

ZAGZAVOD ZA
GRADBENIŠTVO
SLOVENIJESLOVENIAN
NATIONAL BUILDING
AND CIVIL ENGINEERING
INSTITUTEČlan
Member of

www.eta.eu

**Dimičeva 12,
1000 Ljubljana, Slovenija**

Tel.: +386 (0)1 280 44 72, +386 (0)1-280 45 37

Fax: +386 (0)1 280 44 84

e-mail: info.ta@zag.si

http://www.zag.si

European Technical Assessment

**ETA-18/0221
of 6. 4 2018***English version prepared by ZAG*

General Part

Organ za tehnično ocenjevanje, ki je izdal ETA
*Technical Assessment Body issuing the ETA***ZAG Ljubljana****Komercialno ime gradbenega proizvoda**
*Trade name of the construction product***EJOT concrete screw JC2****Družina proizvoda, ki ji gradbeni proizvod
pripada****33: Vijak za beton velikosti 6 za
skupinsko nekonstrukcijsko uporabo
v betonu in prednapetih votlih
ploščah***Product family to which the construction product belongs***33: Concrete screw of size 6 for multiple use for non-
structural application in concrete and in pre-
stressed hollow core slabs****Proizvajalec**
*Manufacturer***EJOT BAUBEFESTIGUNGEN GmbH**
In der Stockwiese 35
57334 BAD LAASPHE
Germany
<http://www.ejot.com/>**Proizvodni obrat**
*Manufacturing plant***EJOT Plant 14****Ta Evropska tehnična ocena vsebuje***This European Technical Assessment contains***14 strani vključno s 11 prilogami, ki so
sestavni del te ocene****14 pages including 11 annexes which form an
integral part of this assessment****Ta Evropska tehnična ocena je izdana na
podlagi Uredbe (EU) št. 305/2011 na podlagi***This European Technical Assessment is issued in
accordance to Regulation (EU) No 305/2011, on the basis of***ETAG 001 – del 1 in 6, izdaja 2013, ki se
uporablja kot Evropski ocenitveni dokument
(EAD)****ETAG 001 – part 1 and 6, edition 2013, used as
European Assessment Document (EAD)**

Translations of this European Technical Assessment in other languages shall fully correspond to the original issued document and should be identified as such.

Communication of this European Technical Assessment, including transmission by electronic means, shall be in full (excepted the confidential Annex(es) referred to above). However, partial reproduction may be made, with the written consent of the issuing Technical Assessment Body. Any partial reproduction has to be identified as such.

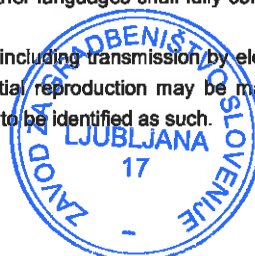

Specific parts

1. Technical description of the product

The EJOT concrete screw JC2 is an anchor in size 6 made of galvanised steel. The anchor is screwed into a predrilled cylindrical hole. The special thread of the anchor cuts an internal thread into the member while setting. The anchorage is characterised by mechanical interlock in the special thread.

For the installed anchor see Figure given in Annex A1.

2. Specification of the intended use(s) in accordance with the applicable European Assessment Document (hereinafter EAD)

The performances given in Chapter 3 are only valid if the anchor is used in compliance with the specifications and conditions given in Annex B.

The provisions made in this European Technical Assessment are based on an assumed working life of the anchor of 50 years. The indications given on the working life cannot be interpreted as a guarantee given by the manufacturer, but are to be regarded only as a means for choosing the right products in relation to the expected economically reasonable working life of the works.

3. Performance of the product and references to the methods used for its assessment

3.1 Mechanical resistance and stability (BWR 1)

For basic work requirement mechanical resistance and stability are included under the basic work requirement safety in use.

3.2 Safety in case of fire (BWR 2)

The basic work requirements for safety in case of fire are listed in Annex C4.

3.3 Hygiene, health and environment (BWR 3)

Regarding dangerous substances contained in this European Technical Assessment, there may be requirements applicable to the products falling within its scope (e.g. transported European legislation and national laws, regulations and administrative provisions). In order to meet provisions of the regulation (EU) No 305/2011, these requirements need also to be complied with, when they apply.

3.4 Safety in use (BWR 4)

The basic work requirements for safety in use are listed in Annexes C1, C2 and C3.

3.5 Protection against noise (BWR 5)

Not relevant.

3.6 Energy economy and heat retention (BWR 6)

Not relevant.

3.7 Sustainable use of natural resources (BWR 7)

No performance assessed.

3.8 General aspects relating to fitness for use

Durability and serviceability are only ensured if specifications of intended use according to Annex B1 are kept.

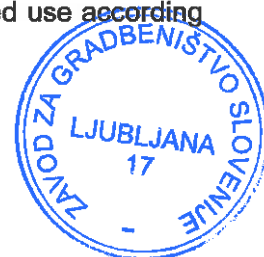

4. Assessment and verification of constancy of performance (hereinafter AVCP) system applied, with reference to its legal base

According to the decision 97/161/EC of the European Commission¹ the system of assessment and verification of constancy of performance (see Annex V to regulation (EU) No 305/2011) 2+ apply.

5. Technical details necessary for the implementation of the AVCP system, as provided for in the applicable EAD

Technical details necessary for the implementation of the AVCP system are laid down in the Control plan deposited at the Slovenian National Building and Civil Engineering Institute (ZAG).

Issued in Ljubljana on 6. 4. 2018

Signed by:
Franc Capuder, M.Sc.
Head of Service of TAB 17



¹

Official Journal of the European Communities L 254 of 8.10.1996

EJOT concrete screw JC2 after installation

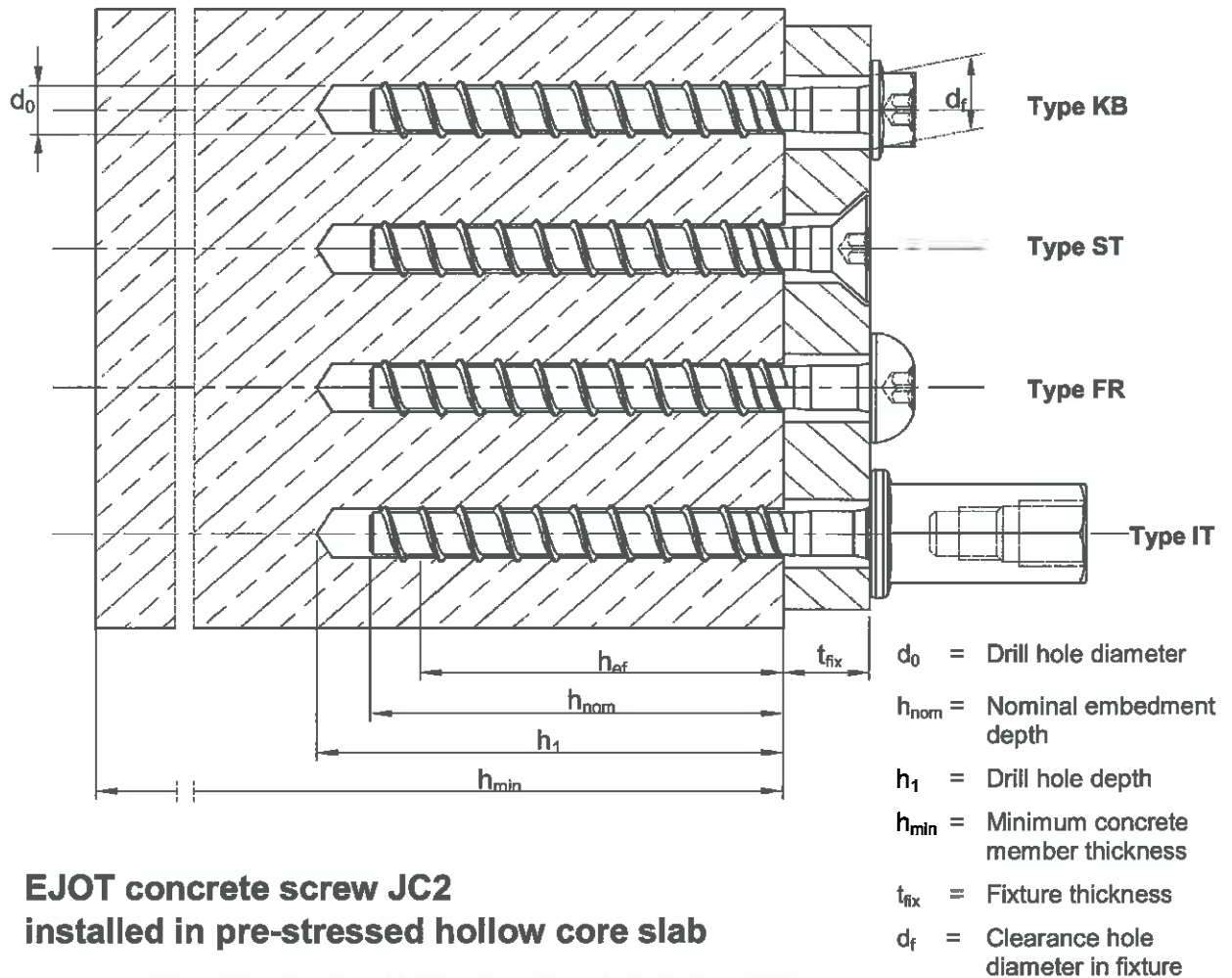

EJOT concrete screw JC2 installed in pre-stressed hollow core slab

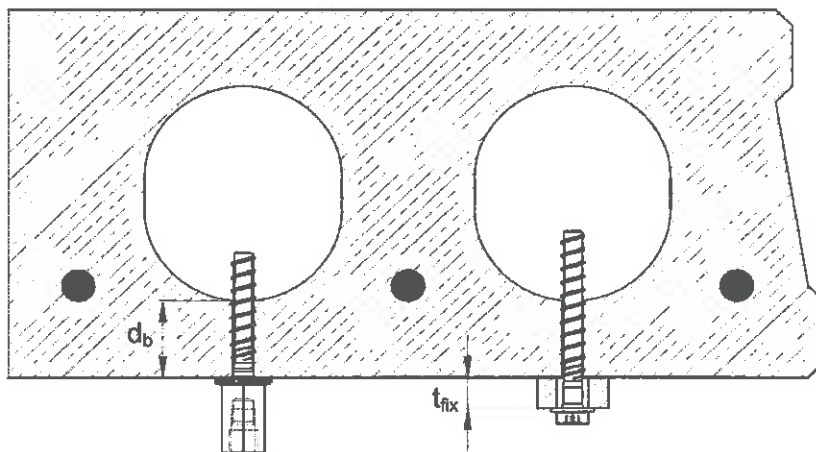

EJOT concrete screw JC2

Product description
 Installation condition

Annex A1



Table A1: Materials and Types



Material		f_{yk} [N/mm ²]	f_{uk} [N/mm ²]
Cold forged carbon steel, zinc electroplated according to EN ISO 4042 $\geq 5\mu\text{m}$		640	800
Part	Designation	Description	Design
1	JC2-KB	Hexagonal head version with combined washer and T-drive	
2	JC2-ST	Countersunk head version with T-drive	
3	JC2-FR	Pan head version with T-drive	
4	JC2-IT	Internal thread version with hexagonal drive	

Table A2: Anchor dimensions and head marking

Anchor size		JC2-6	Marking: Identifying mark: S Anchor identity: CSA Nominal diameter: d_{nom} Screw length: L Example: S-CSA 6x100 or JC2-6x100
Nominal diameter	d_{nom} [mm]	6	
Thread outer diameter	d_{th} [mm]	7,45	
Core diameter	d_k [mm]	5,50	
Shaft diameter	d_s [mm]	5,88	
Stressed section	A_s [mm ²]	23,76	

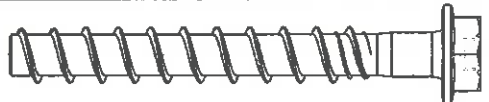
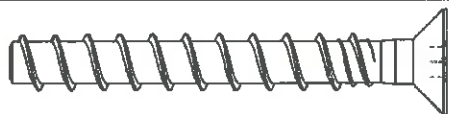
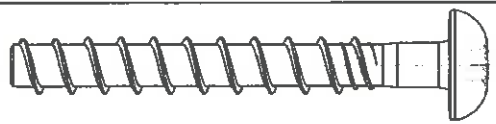

EJOT concrete screw JC2

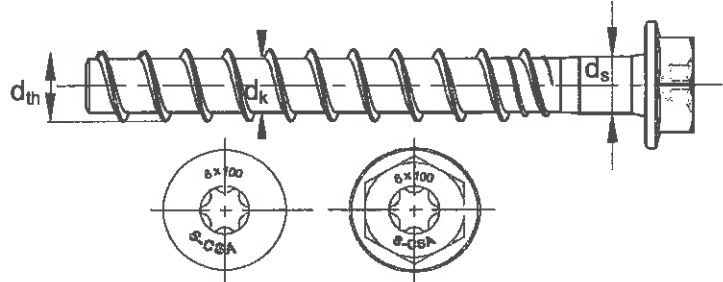
Product description
Materials, types and dimensions

Annex A2



Specifications of intended use

Anchorage subjected to:

- Static, quasi static load.
- Use only for multiple use for non-structural applications according to ETAG 001, Part 6
- Fire exposure.

Base materials:

- Cracked and non-cracked concrete.
- Reinforced and unreinforced normal weight concrete of strength class C20/25 at minimum and C50/60 at maximum according to EN 206:2013+A1:2016.
- Precast pre-stressed hollow core slabs.

Use conditions (Environmental conditions):

- The anchor may be used in structures subject to dry internal conditions.

Design:

- Anchorages are designed under the responsibility of an engineer experienced in anchorages and concrete work.
- Anchorages under static and quasi-static actions are designed in accordance with EOTA TR 055, Edition December 2016 or CEN/TS 1992-4-4.
- For application with resistance under fire exposure the anchorages are designed in accordance with the method given in EOTA TR 020, Edition May 2004.
- Verifiable calculation notes and drawings are prepared taking into account of the load to be anchored. The position of the anchor is indicated on the design drawings (e.g. position of the anchor relative to reinforcement or to supports, etc.).

Installation:

- Anchor installation carried out by appropriately qualified personnel and under the supervision of the person responsible for technical matters on the site.
- Use of the anchor only as supplied by the manufacturer without exchanging the components of an anchor.
- Anchor installation in accordance with the manufacturer's specifications and drawings using the appropriate tools.
- Checks before placing the anchor to ensure that the strength class of the concrete in which the anchor is to be placed is in the range given and is not lower than that of the concrete to which the characteristic loads apply for.
- Check of concrete being well compacted, e.g. without significant voids.
- Cleaning of the hole of drilling dust.
- Anchor installation ensuring the specified embedment depth.
- Keeping of the edge distance and spacing to the specified values without minus tolerances.
- Positioning of the drill holes without damaging the reinforcement.
- In case of aborted hole, drilling of new hole at a minimum distance of twice the depth of the aborted hole, or smaller distance provided the aborted drill hole is filled with high strength non-shrinkage mortar. No shear or oblique tension loads are allowed in the direction of a not filled aborted hole.
- Application of the torque moment given in Annex B2 using a calibrated torque wrench.

EJOT concrete screw JC2

Intended use
Specifications

Annex B1



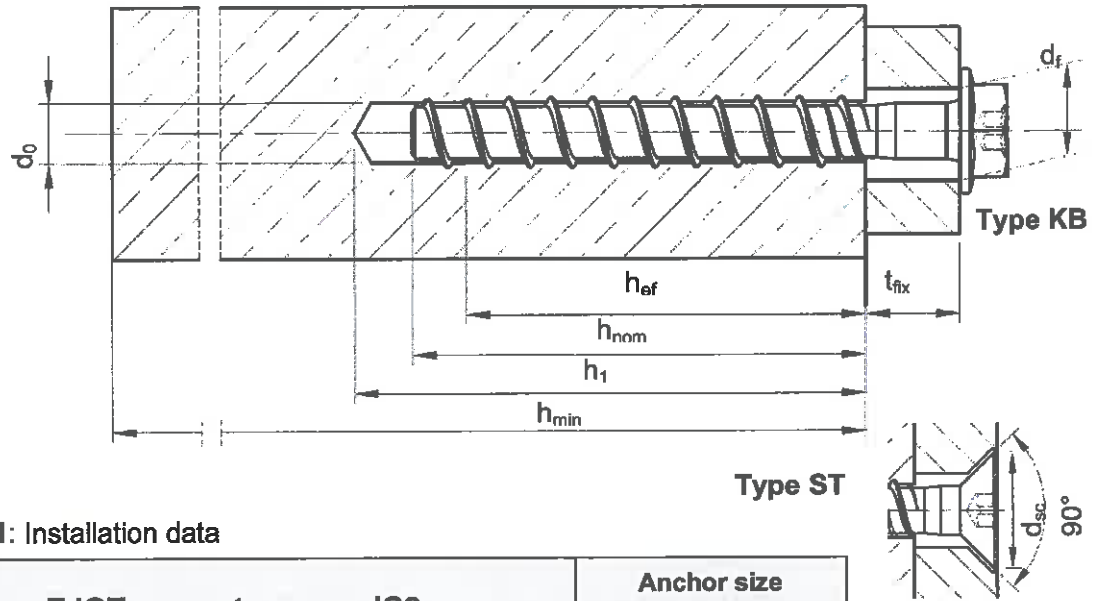

Table B1: Installation data

EJOT concrete screw JC2			Anchor size
			JC2 6
Nominal embedment depth	h_{nom}	[mm]	40
Drill hole diameter	d_0	[mm]	6
Cutting diameter at the upper tolerance limit (maximum diameter bit)	$d_{cut,max} \leq$	[mm]	6,40
Depth of drilled hole to deepest point	$h_1 \geq$	[mm]	50
Effective anchorage depth	h_{ef}	[mm]	31,9
Diameter of clearance hole in the fixture	$d_f \leq$	[mm]	9
Countersunk head diameter (Type CS)	d_{cs}	[mm]	14
T-drive	T-	[-]	30
Width across flats	SW	[mm]	11
Required torque	T_{inst}	[Nm]	14
Max installation torque for impact screw driver	T_{SD}	[Nm]	90

Table B2: Minimum thickness of concrete member, spacing and edge distance

EJOT concrete screw JC2			Anchor size
			JC2- 6
Minimum thickness of concrete member	h_{min}	[mm]	100
Minimum spacing	s_{min}	[mm]	35
Minimum edge distance	c_{min}	[mm]	35

EJOT concrete screw JC2	Annex B2
Intended use Installation data	

Admissible anchor position in pre-stressed hollow core slabs

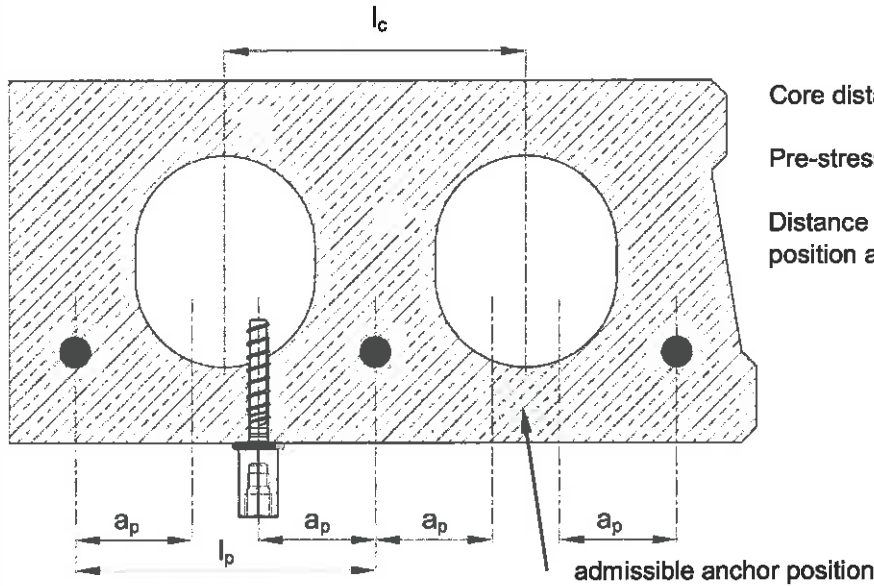

- Core distance $l_c \geq 100 \text{ mm}$
- Pre-stressing steel distance $l_p \geq 100 \text{ mm}$
- Distance between anchor position and prestressing $a_p \geq 50 \text{ mm}$

Minimum spacing and edge distance of anchors and distance between anchor groups in pre-stressed hollow core slabs

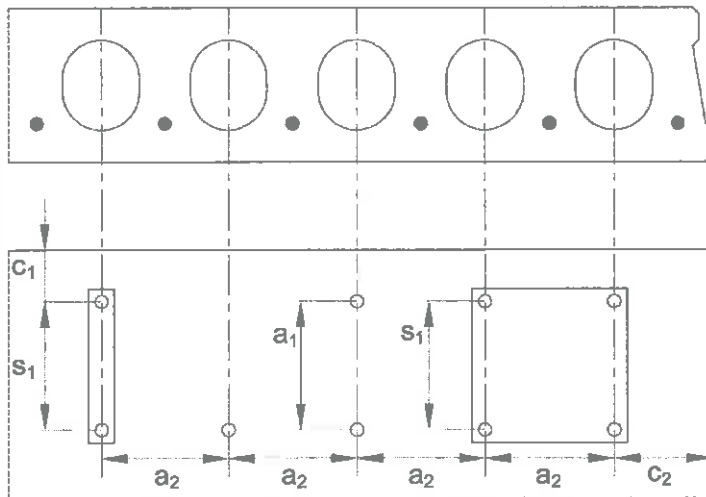

- Minimum edge distance $c_{min} \geq 100 \text{ mm}$
- Minimum anchor spacing $s_{min} \geq 100 \text{ mm}$
- Minimum distance between anchor groups $a_{min} \geq 100 \text{ mm}$

- c_1, c_2 edge distance
- s_1, s_2 anchor spacing
- a_1, a_2 distance between anchor groups

EJOT concrete screw JC2

Intended use

Installation data for pre-stressed hollow core slabs



Installation instructions

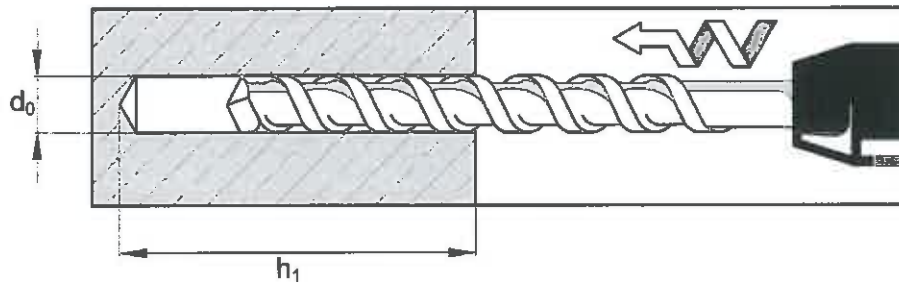

Make a cylindrical hole

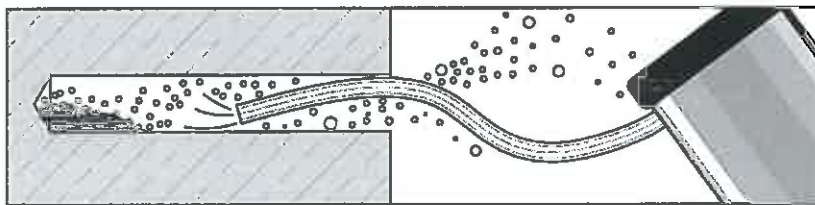

Clean the hole

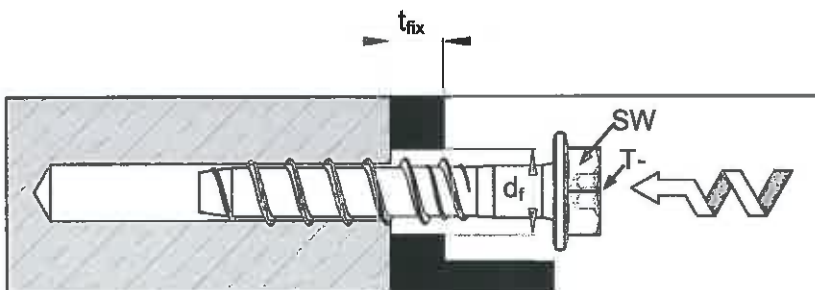

Install the screw anchor by impact screwdriver or torque wrench

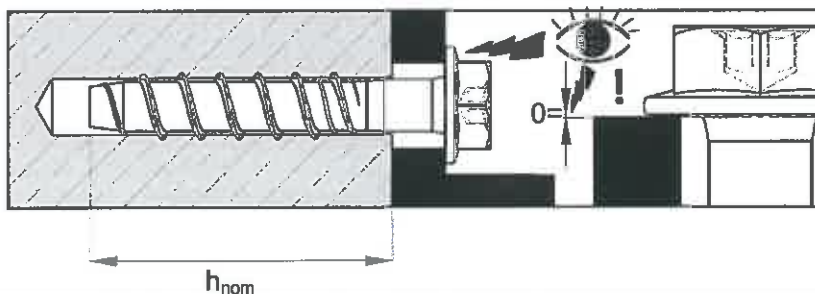

Ensure that the screw anchor head fully rests without any gap on the fixture and is not damaged

EJOT concrete screw JC2

Intended use

Installation instructions in concrete

Annex B4



Installation instructions in pre-stressed hollow core slabs

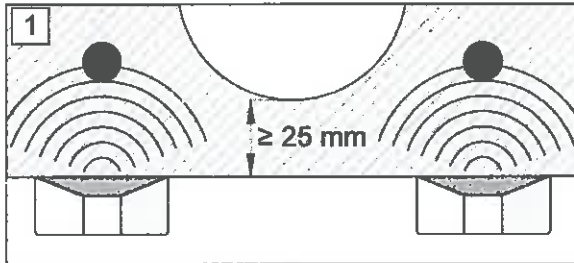

1 Locate rebars by means of suitable detector

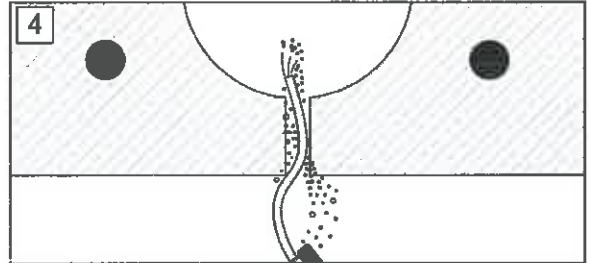

4 Clean the hole

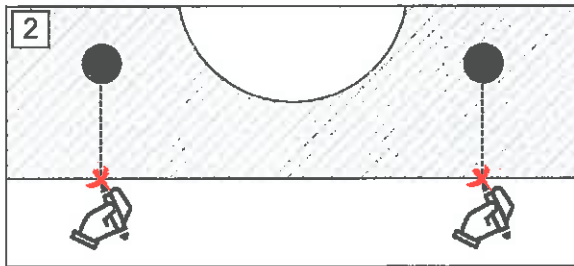

2 Mark rebar location

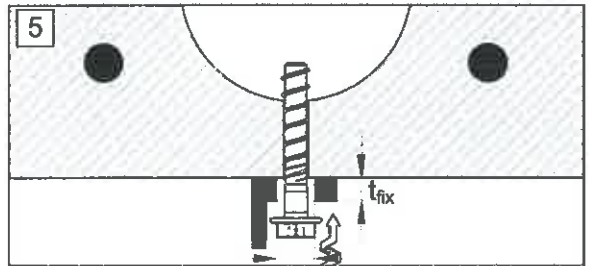

5 Install the screw anchor by impact screwdriver or torque wrench

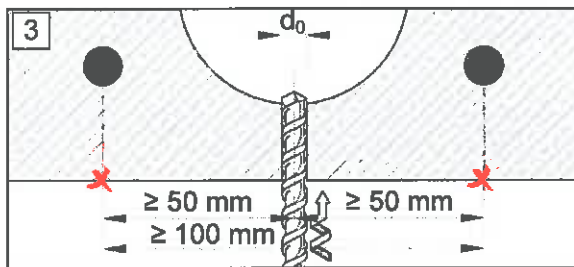

3 Make a cylindrical hole

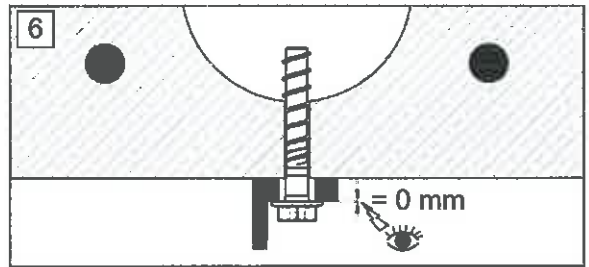

6 Ensure that the screw anchor head fully rests without any gap on the fixture and is not damaged

EJOT concrete screw JC2

Intended use

Installation instructions in pre-stressed hollow core slabs



Table C1: Characteristic resistances under tension loads in case of static and quasi-static loading for design according to EOTA TR 055 or **CEN/TS-1992-4-4**

EJOT concrete screw JC2			Anchor size
			JC2-6
Steel failure			
Characteristic resistance	$N_{Rk,s}$	[kN]	19,1
Partial safety factor	γ_{Ms} ¹⁾	[-]	1,5
Pull-out failure			
Characteristic resistance in cracked and non-cracked concrete C20/25	$N_{Rk,p}$	[kN]	3
Increasing factor for $N_{Rk,p}$	Ψ_c	C25/30	1,06
		C30/37	1,14
		C35/45	1,22
		C40/50	1,26
		C45/55	1,31
		C50/60	1,35
Partial safety factor	γ_2	[-]	1,0
	γ_{Mp} ¹⁾	[-]	1,5 ²⁾
Concrete cone and splitting failure			
Effective anchorage depth	h_{ef}	[mm]	31,9
Factor for cracked concrete	k_{cr}	[-]	7,2
Factor for non-cracked concrete	k_{ucr}	[-]	10,1
Spacing	$s_{cr,N}$	[mm]	96
Edge distance	$c_{cr,N}$	[mm]	48
Spacing (splitting)	$s_{cr,sp}$	[mm]	96
Edge distance (splitting)	$c_{cr,sp}$	[mm]	48
Partial safety factor	γ_{Msp} ¹⁾	[-]	1,5 ²⁾

¹⁾ In absence of other national regulations

²⁾ The installation safety factor of $\gamma_2 = 1,0$ is included

EJOT concrete screw JC2	
Performance Characteristic resistance under tension loads	

Table C2: Characteristic resistances under shear loads in case of static and quasi-static loading for design according to EOTA TR 055 or CEN/TS-1992-4-4

EJOT concrete screw JC2			Anchor size
			JC2-6
Steel failure without lever arm			
Characteristic resistance	$V_{Rk,s}$	[kN]	9,8
Partial safety factor	$\gamma_{Ms}^{1)}$	[-]	1,25
Factor for considering ductility	k_2	[-]	0,8
Steel failure with lever arm			
Characteristic resistance	$M_{Rk,s}^0$	[Nm]	16
Partial safety factor	$\gamma_{Ms}^{1)}$	[-]	1,25
Concrete pryout failure			
k-factor	$k_{(3)}$	[-]	1,0
Partial safety factor	$\gamma_{Mc}^{1)}$	[-]	1,5
Concrete edge failure			
Effective length of anchor under shear load	l_f	[mm]	31,9
Outside diameter of anchor	d_{nom}	[mm]	6
Cracked concrete without any edge reinforcement	$\Psi_{ucr,V}$	[-]	1,0
Cracked concrete with straight edge reinforcement > $\varnothing 12$ mm			1,2
Cracked concrete with edge reinforcement and closely spaced stirrups ($a \leq 100$ mm) or non-cracked concrete			1,4
Partial safety factor			$\gamma_{Mc}^{1)}$

¹⁾ In absence of other national regulations

EJOT concrete screw JC2	Annex C2
Performance Characteristic resistance under shear loads	



Table C3: Characteristic resistances for precast pre-stressed hollow core slabs C30/37 to C50/60

EJOT concrete screw JC2			Anchor size		
			JC2-6		
Installation safety factor	$\gamma_2 = \gamma_{inst}$	[-]	1,0		
Flange thickness	d_b	[mm]	≥ 25	≥ 30	≥ 40
Characteristic resistance for all directions	F_{Rk}	[kN]	1	2	3
Characteristic bending moment	$M^0_{Rk,s}$	[Nm]	16		
Edge distance	$c_{cr} = c_{min}$	[mm]	100		
Spacing	$s_{cr} = s_{min}$	[mm]	100		

EJOT concrete screw JC2

Performance

Characteristic resistances for precast pre-stressed hollow core slabs

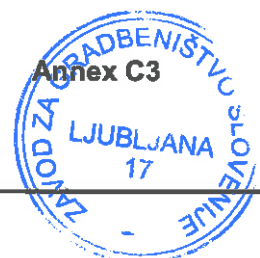
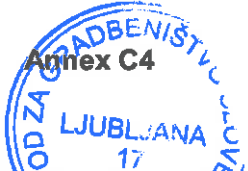

Table C4: Characteristic resistances under fire exposure¹⁾

EJOT concrete screw JC2			Anchor size
			JC2-6
Steel failure			
Characteristic tension and shear resistance $N_{Rk,s,fi} = V_{Rk,s,fi}$	R30	[kN]	0,24
	R60	[kN]	0,22
	R90	[kN]	0,17
	R120	[kN]	0,12
Steel failure with lever arm			
Characteristic resistance $M^0_{Rk,s,fi}$	R30	[Nm]	0,19
	R60	[Nm]	0,18
	R90	[Nm]	0,14
	R120	[Nm]	0,10
Spacing	$s_{cr,N,fi}$	[mm]	4 x h_{ef}
Edge distance	$c_{cr,N,fi}$	[mm]	2 x h_{ef} Fire attack from more than one side: $c_{min} \geq 300 \text{ mm}$ and $\geq 2 \times h_{ef}$

¹⁾ The values are not for use in precast pre-stressed hollow core slabs

The characteristic resistance for pull-out, concrete cone failure, concrete pry-out and concrete edge failure shall be calculated according to EOTA TR 020 or CEN/TS 1992-4-4

EJOT concrete screw JC2	
Performance Characteristic resistances under fire exposure	